

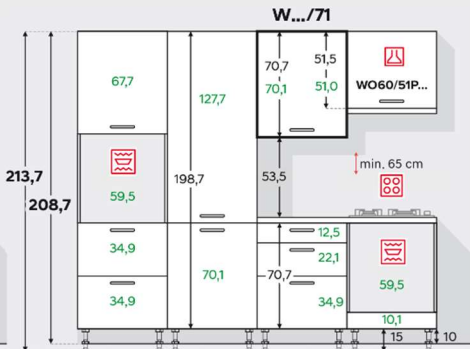

CATÁLOGO TÉCNICO

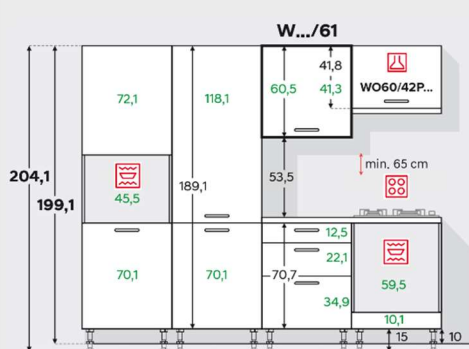

COLOR VERDE: EL ALTO DE LOS FRENTE / ELECTRODOMÉSTICOS

COLOR NEGRO: EL ALTO DE LOS CASCOS

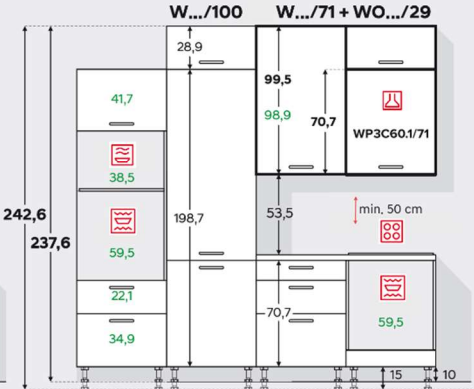
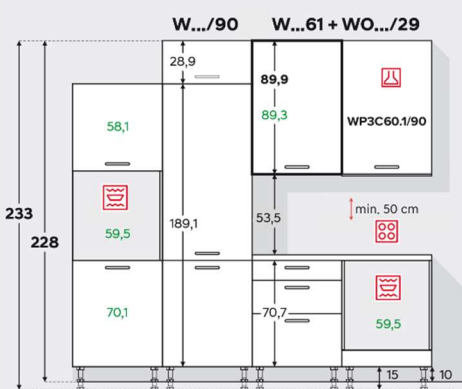

PLACA



CAMPANA



HORNO



MICROONDAS



FREGADERO



LAVAVAJILLAS



NEVERA



ARMARIOS INFERIORES

ALTO: 70,7 CM
PATAS: 10/15 CM
FONDO: D ... - 51 CM /
BD ... - 58 CM

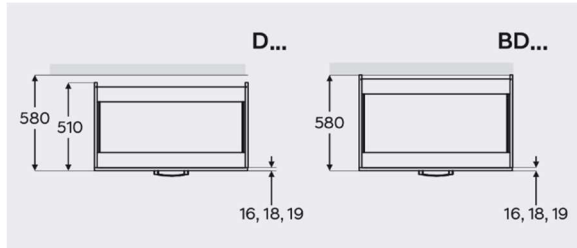

C ...: cesta cargo

CE ...: cesta cargo con fondo completo

SS ...: cajón de cierre suave (soft close) 45 cm

ST ...: cajón de cierre suave (Blum) 50 cm



símbolo	ancho cm	descripción
DC15	15	15 cm x 70,7 cm x 51 cm con cesta cargo
BDC20	20	20 cm x 70,7 cm x 58 cm con cesta cargo
BDCE15	15	15 cm x 70,7 cm x 58 cm con cesta cargo dcha. o izq. con fondo completo
BDCE20	20	20 cm x 70,7 cm x 58 cm con cesta cargo dcha. o izq. con fondo completo



símbolo	ancho cm	descripción
DC30	30	30 cm x 70,7 cm x 51 cm con cesta cargo
BDC30	30	30 cm x 70,7 cm x 58 cm con cesta cargo
BDCE30	30	30 cm x 70,7 cm x 58 cm con cesta cargo dcha. o izq. con fondo completo



símbolo	ancho cm	descripción
DSS ... /1/1	40 / 50 / 60	... cm x 70,7 cm x 51 cm de un cajón con cierre suave (soft close) 45cm
BDSS ... /1/1	40 / 50 / 60	... cm x 70,7 cm x 58 cm de un cajón con cierre suave (soft close) 45cm
BDST ... /1/1	40 / 50 / 60	... cm x 70,7 cm x 58 cm de un cajón con cierre suave (Blum) 50 cm



símbolo	ancho cm	descripción
DSS ... /3	40 / 45 / 50 / 55 / 60 / 65 / 70 / 75 / 80 / 85 / 90	... cm x 70,7 cm x 51 cm de 3 cajones con cierre suave (soft close) 45cm
BDSS ... /3	40 / 45 / 50 / 55 / 60 / 65 / 70 / 75 / 80 / 85 / 90	... cm x 70,7 cm x 58 cm de 3 cajones con cierre suave (soft close) 45cm
BDST ... /3	40 / 45 / 50 / 55 / 60 / 65 / 70 / 75 / 80 / 85 / 90	... cm x 70,7 cm x 58 cm de 3 cajones con cierre suave (Blum) 50 cm



símbolo	ancho cm	descripción
DSS ... /2PL	60 / 70 / 80 / 90	... cm x 70,7 cm x 51 cm de 2 cajones con cierre suave (soft close) 45cm
BDSS ... /2PL	60 / 70 / 80 / 90	... cm x 70,7 cm x 58 cm de 2 cajones con cierre suave (soft close) 45cm
BDST ... /2PL	60 / 70 / 80 / 90	... cm x 70,7 cm x 58 cm de 2 cajones con cierre suave (Blum) 50 cm



ARTE COCINA DESIGN

www.artecocinadesign.com

tel.: (0034) 611 580 888



símbolo	ancho cm	descripción
D1	30 / 35 / 40 / 45 / 50 / 55 / 60	... cm x 70,7 cm x 51 cm con una puerta
BD1	30 / 35 / 40 / 45 / 50 / 55 / 60	... cm x 70,7 cm x 58 cm con una puerta

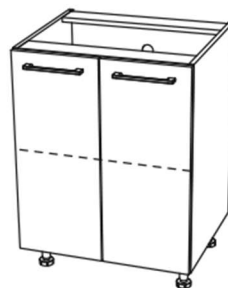

símbolo	ancho cm	descripción
D ...	60 / 70 / 80	... cm x 70,7 cm x 51 cm con 2 puertas
BD ...	60 / 70 / 80	... cm x 70,7 cm x 58 cm con 2 puertas

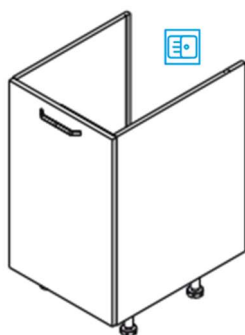

símbolo	ancho cm	descripción
DZ1	45 / 50 / 60	armario bajo fregadero con una puerta
BDZ1	45 / 50 / 60	

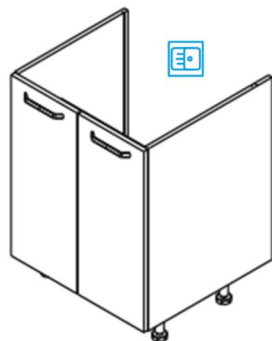

símbolo	ancho cm	descripción
DZ ...	60 / 70 / 80 / 90	armario bajo fregadero con 2 puertas
BDZ ...	60 / 70 / 80 / 90	

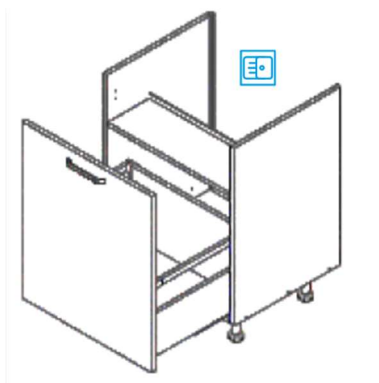

símbolo	ancho cm	descripción
DZCSS ...	45 / 50 / 60 / 80	armario bajo fregadero con 1 puerta con cierre suave (soft close)
BDZCSS ...	45 / 50 / 60 / 80	
BDZCST ... P45 (longitud del riel/guía de 45 cm)	45 / 50 / 60 / 80	armario bajo fregadero con con 1 puerta con cierre suave (Blum)



ARTE COCINA DESIGN

www.artecocinadesign.com

tel.: (0034) 611 580 888

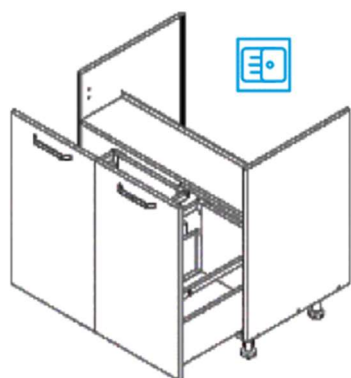

símbolo	ancho cm	descripción
DZC2SS80	80	armario bajo fregadero con 2 puertas con cierre suave (soft close)
BDZC2SS80	80	
BDZC2ST80P45 (longitud del riel/guía de 45 cm)	80	armario bajo fregadero con 2 puertas con cierre suave (Blum)

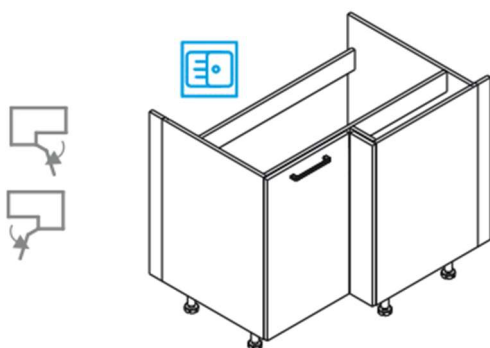

símbolo	ancho cm	descripción
DRZ100X70	100X70	armario esquinero bajo fregadero

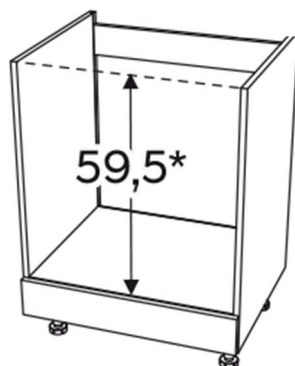

símbolo	ancho cm	descripción
DP ...	45 / 60	armario para placa de cocina y horno con cajón
BDP ...	45 / 60	

* dimensiones externas del electrodoméstico

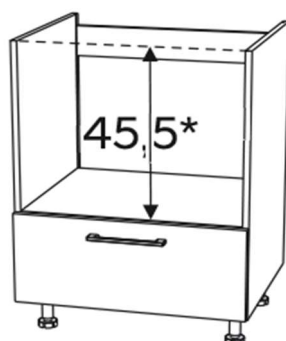

símbolo	ancho cm	descripción
DPKSS60	60	armario para placa de cocina y horno compacto con cajón cierre suave (soft close) 45 cm
BDPKSS60	60	
BDPKST60	60	armario para placa de cocina y horno compacto con cajón cierre suave Blum

* dimensiones externas del electrodoméstico

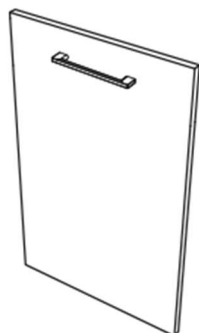

símbolo	ancho cm	descripción
FZMYW	45 / 60	frontal del lavavajillas

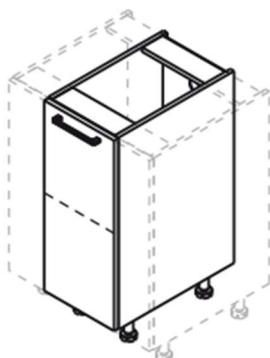

símbolo	ancho cm	descripción
D1_SPEC	20 < ... > 59	armario especial, ancho cada 1 cm con una puerta

ARMARIOS INFERIORES ESQUINEROS

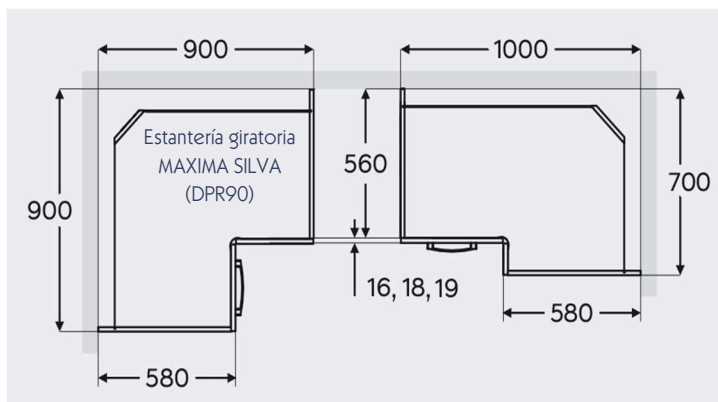

ALTO: 70,7 CM

PATAS: 10/15 CM

SÍMBOLO: DRP90 (90 cm x 90 cm)

DRP90x70 (90 cm x 70 cm), dcha. o izq.

DRP90x100 (90 cm x 100 cm) dcha. o izq.

DRP100x70 (100 cm x 70 cm) dcha. o izq.

ALTO: 70,7 CM

PATAS: 10/15 CM

SÍMBOLO: DPRP110X65 (110 cm x 65 cm), dcha. o izq.

DPRP115X65 (115 cm x 65 cm), dcha. o izq.

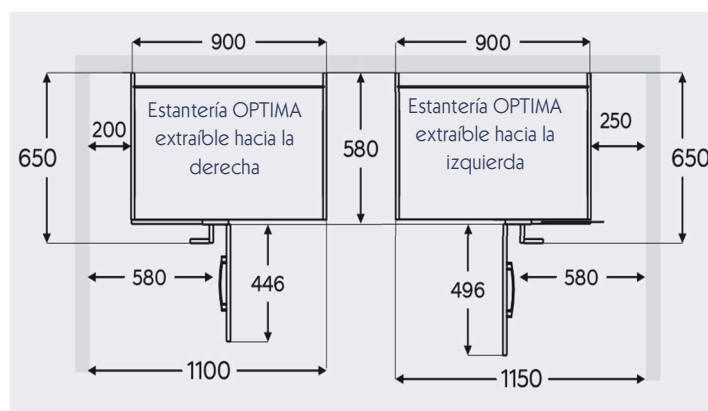



ARTE COCINA DESIGN

www.artecocinadesign.com

tel.: (0034) 611 580 888

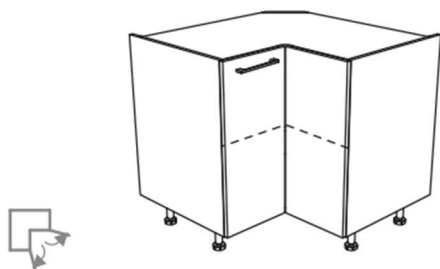

símbolo	ancho cm	descripción
DRP90	90 x 90 / 70,7 / 58	armario esquinero con estantería giratoria MAXIMA SILVA

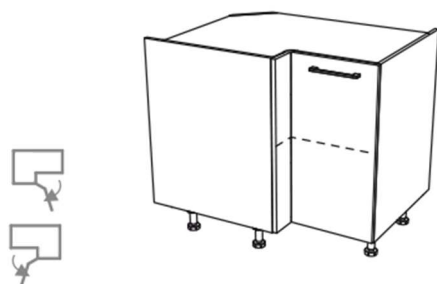

símbolo	ancho cm	descripción
DRP90x70	90 x 70 / 70,7 / 58	armario esquinero con estantería giratoria MAXIMA SILVA



símbolo	ancho cm	descripción
DRP100x70	100 x 70 / 70,7 / 58	armario esquinero

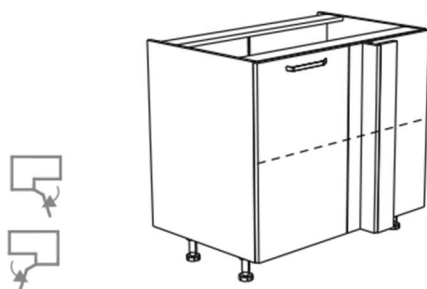

símbolo	ancho cm	descripción
DPRP110x65	110 x 65 / 70,7 / 58	armario esquinero con estantería OPTIMA
DPRP115x65	115 x 65 / 70,7 / 58	



ZÓCALOS



10
15

zócalo con junta

L = 200 CM

colores: BLANCO, ALUMINIO, NEGRO MATE



10
15

conector / esquina

colores: BLANCO, ALUMINIO, NEGRO MATE

COLUMNAS PARA ARMARIOS COLGANTES

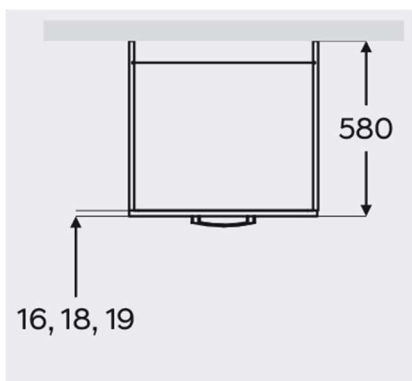

ALTO: 189 CM (sin contar el

alto de las patas)

PATAS: 10/15 CM

FONDO: 58 CM



push-to-open: abre con un ligero empujón en el panel frontal. Opción disponible para armarios sobre electrodomésticos con frontales: P2, P4, M4 y F



... / 61

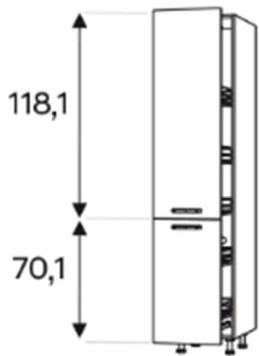

símbolo	ancho cm	descripción
SCMAX ...	30 / 40	columna con cesta de 5 niveles hasta 120 kg, cierre suave (soft close) 45 cm

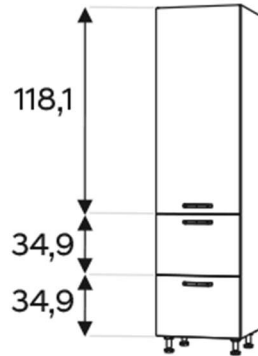

símbolo	ancho cm	descripción
SD ... SS2	40 / 50 / 60	columna de 2 cajones con cierre suave (soft close) 45 cm
SD ... ST2	40 / 50 / 60	columna de 2 cajones con cierre suave (Blum) 50 cm

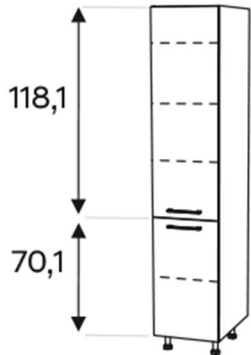

símbolo	ancho cm	descripción
SD ... D2	30 / 40 / 50 / 60	columna con 5 baldas

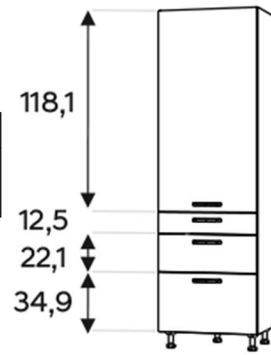

símbolo	ancho cm	descripción
SD ... SS3	40 / 50 / 60	columna de 3 cajones con cierre suave (soft close) 45 cm
SD ... ST3	40 / 50 / 60	columna de 3 cajones con cierre suave (Blum) 50 cm

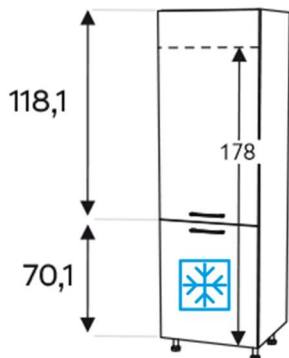

símbolo	ancho cm	descripción
SL60	60	armario para frigorífico integrable, altura exterior de la nevera 178 cm

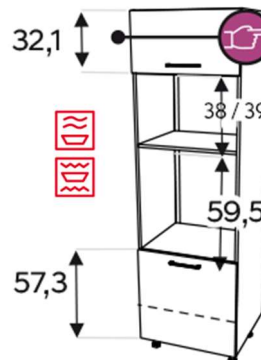

símbolo	ancho cm	descripción
SPM60	60	armario para microondas y horno con baldas

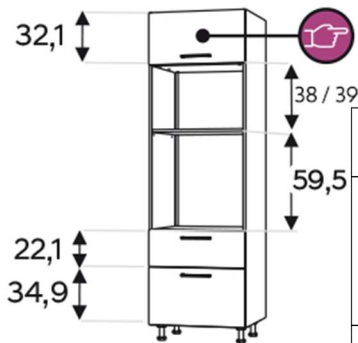

símbolo	ancho cm	descripción
SPM60SS2	60	armario para microondas y horno de 2 cajones cierre suave (soft close) 45 cm
SPM60ST2	60	armario para microondas y horno de 2 cajones cierre suave (Blum) 50 cm

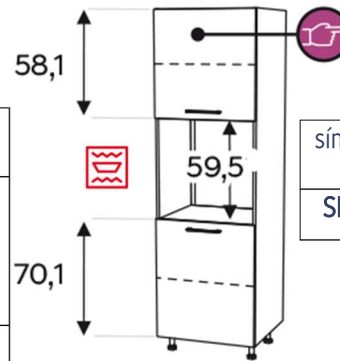

símbolo	ancho cm	descripción
SDP60	60	armario para horno con baldas

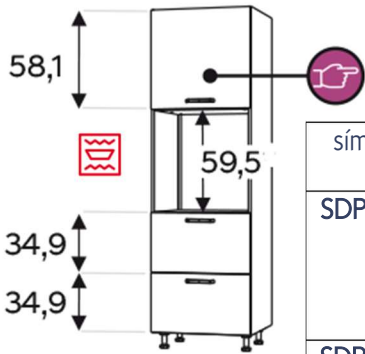

símbolo	ancho cm	descripción
SDP60SS2	60	armario para horno de 2 cajones con cierre suave (soft close) 45 cm
SDP60ST2	60	armario para horno de 2 cajones con cierre suave (Blum) 50 cm

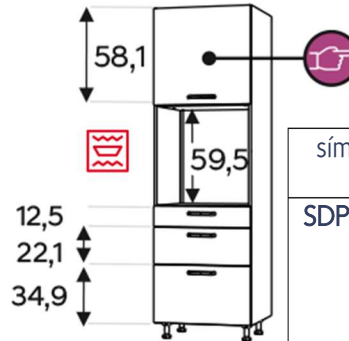

símbolo	ancho cm	descripción
SDP60SS3	60	armario para horno de 3 cajones con cierre suave (soft close) 45 cm
SDP60ST3	60	armario para horno de 3 cajones con cierre suave (Blum) 50 cm

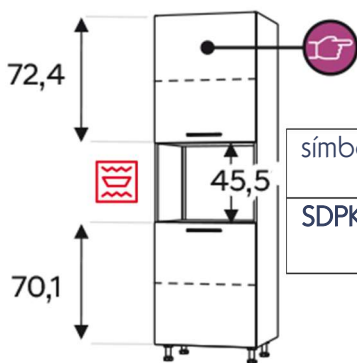

símbolo	ancho cm	descripción
SDPK60	60	armario para horno compacto con baldas

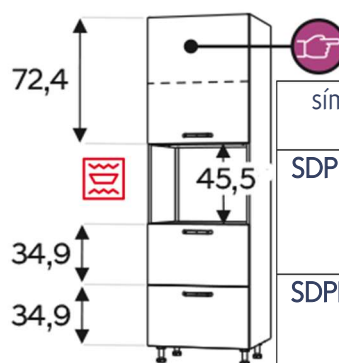

símbolo	ancho cm	descripción
SDPK60SS2	60	armario para horno compacto de 2 cajones con cierre suave (soft close) 45 cm
SDPK60ST2	60	armario para horno compacto de 2 cajones con cierre suave (Blum) 50 cm

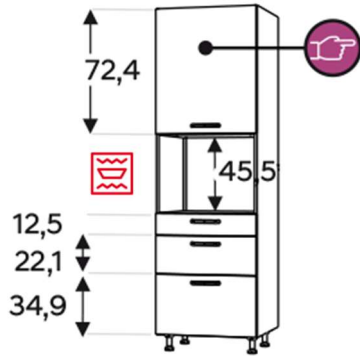

símbolo	ancho cm	descripción
SDPK60SS3	60	armario para horno compacto de 3 cajones con cierre suave (soft close) 45 cm
SDPK60ST3	60	armario para horno compacto de 3 cajones con cierre suave (Blum) 50 cm

... / 71

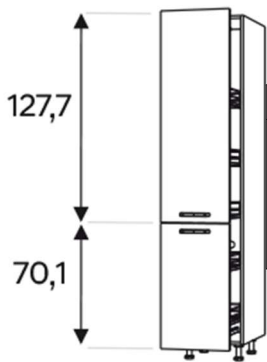

símbolo	ancho cm	descripción
SCMAX ... /71	30 / 40	columna con cesta de 5 niveles hasta 120 kg, cierre suave (soft close) 45 cm

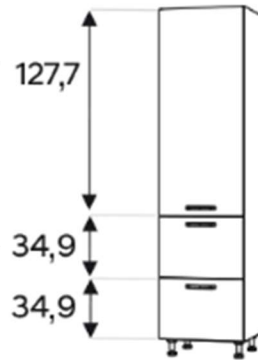

símbolo	ancho cm	descripción
SD ... SS2/71	40 / 50 / 60	columna de 2 cajones con cierre suave (soft close) 45 cm
SD ... ST2/71	40 / 50 / 60	columna de 2 cajones con cierre suave (Blum) 50 cm

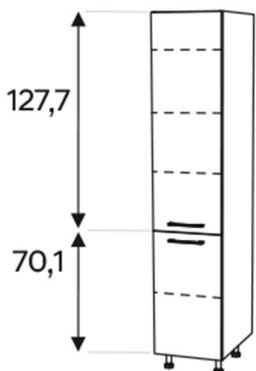

símbolo	ancho cm	descripción
SD ... D2/71	30 / 40 / 50 / 60	columna con 5 baldas

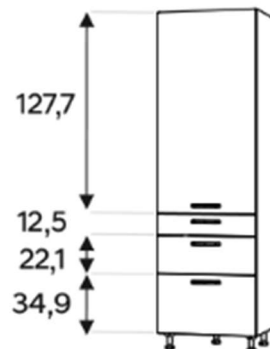

símbolo	ancho cm	descripción
SD ... SS3/71	40 / 50 / 60	columna de 3 cajones con cierre suave (soft close) 45 cm
SD ... ST3/71	40 / 50 / 60	columna de 3 cajones con cierre suave (Blum) 50 cm

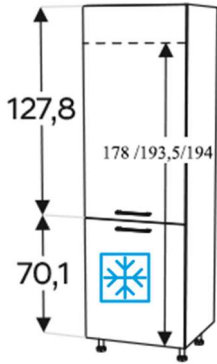

símbolo	ancho cm	descripción
SL60/71	60	armario para frigorífico integrable, altura exterior de la nevera 178 cm
SL75/71	75	armario para frigorífico integrable, altura exterior de la nevera 178 cm / 193,5 cm / 194 cm

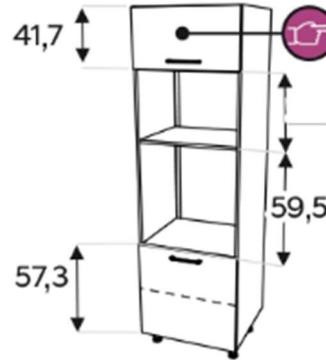

símbolo	ancho cm	descripción
SPM60/71	60	armario para microondas y horno con baldas

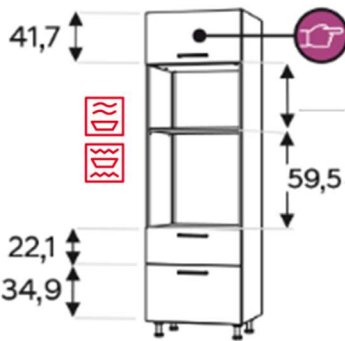

símbolo	ancho cm	descripción
SPM60SS2/71	60	armario para microondas y horno de 2 cajones cierre suave (soft close) 45 cm
SPM60ST2/71	60	armario para microondas y horno de 2 cajones cierre suave (Blum) 50 cm

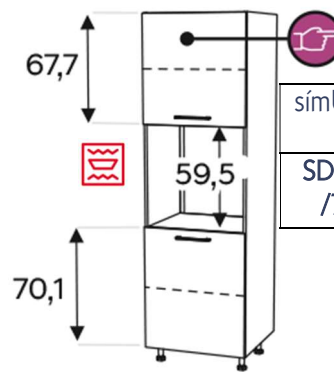

símbolo	ancho cm	descripción
SDP60/71	60	armario para horno con baldas

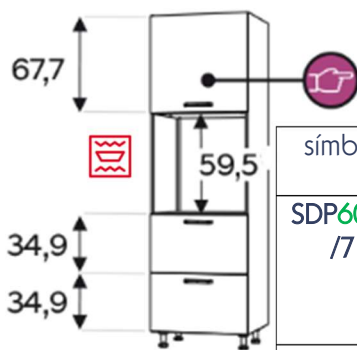

símbolo	ancho cm	descripción
SDP60SS2/71	60	armario para horno de 2 cajones con cierre suave (soft close) 45 cm
SDP60ST2/71	60	armario para horno de 2 cajones con cierre suave (Blum) 50 cm

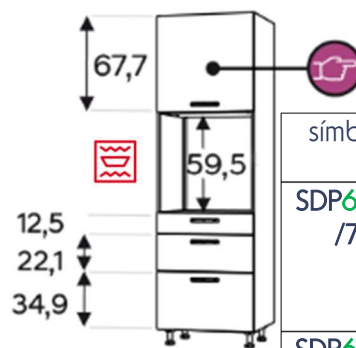

símbolo	ancho cm	descripción
SDP60SS3/71	60	armario para horno de 3 cajones con cierre suave (soft close) 45 cm
SDP60ST3/71	60	armario para horno de 3 cajones con cierre suave (Blum) 50 cm

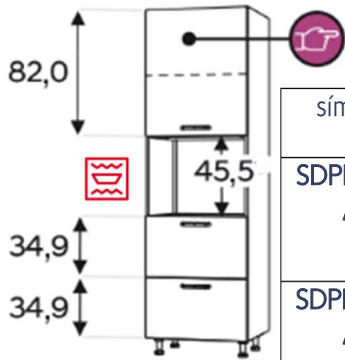

símbolo	ancho cm	descripción
SDPK60SS2 /71	60	armario para horno compacto de 2 cajones con cierre suave (soft close) 45 cm
SDPK60ST2 /71	60	armario para horno compacto de 2 cajones con cierre suave (Blum) 50 cm

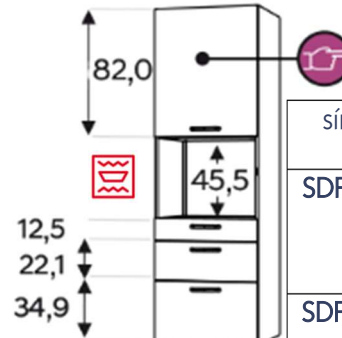

símbolo	ancho cm	descripción
SDPK60SS3	60	armario para horno compacto de 3 cajones con cierre suave (soft close) 45 cm
SDPK60ST3	60	armario para horno compacto de 3 cajones con cierre suave (Blum) 50 cm

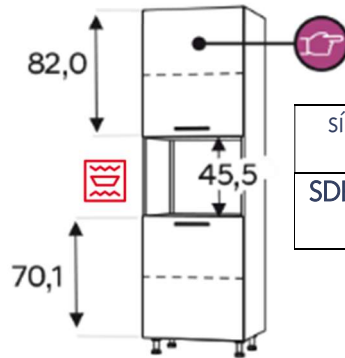

símbolo	ancho cm	descripción
SDPK60/71	60	armario para horno compacto con baldas

ARMARIOS ESQUINEROS

.../61

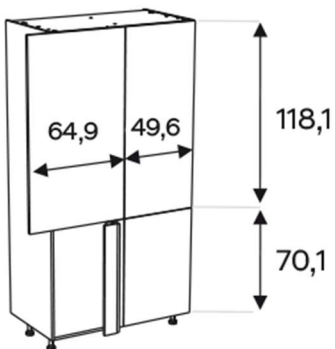

símbolo	ancho cm	descripción
SPRP115X65	115X65	armario "despensa" esquinero, opción izquierda / derecha

.../71

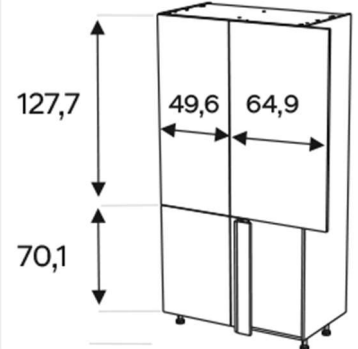
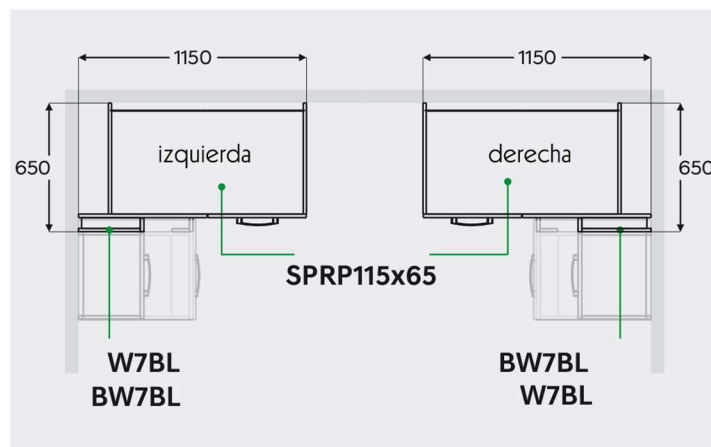

símbolo	ancho cm	descripción
SPRP115X65 /71	115X65	armario "despensa" esquinero, opción izquierda / derecha

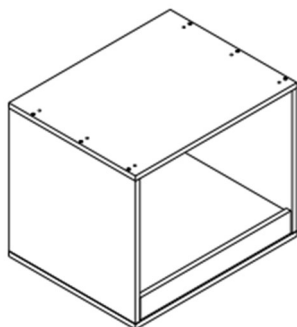
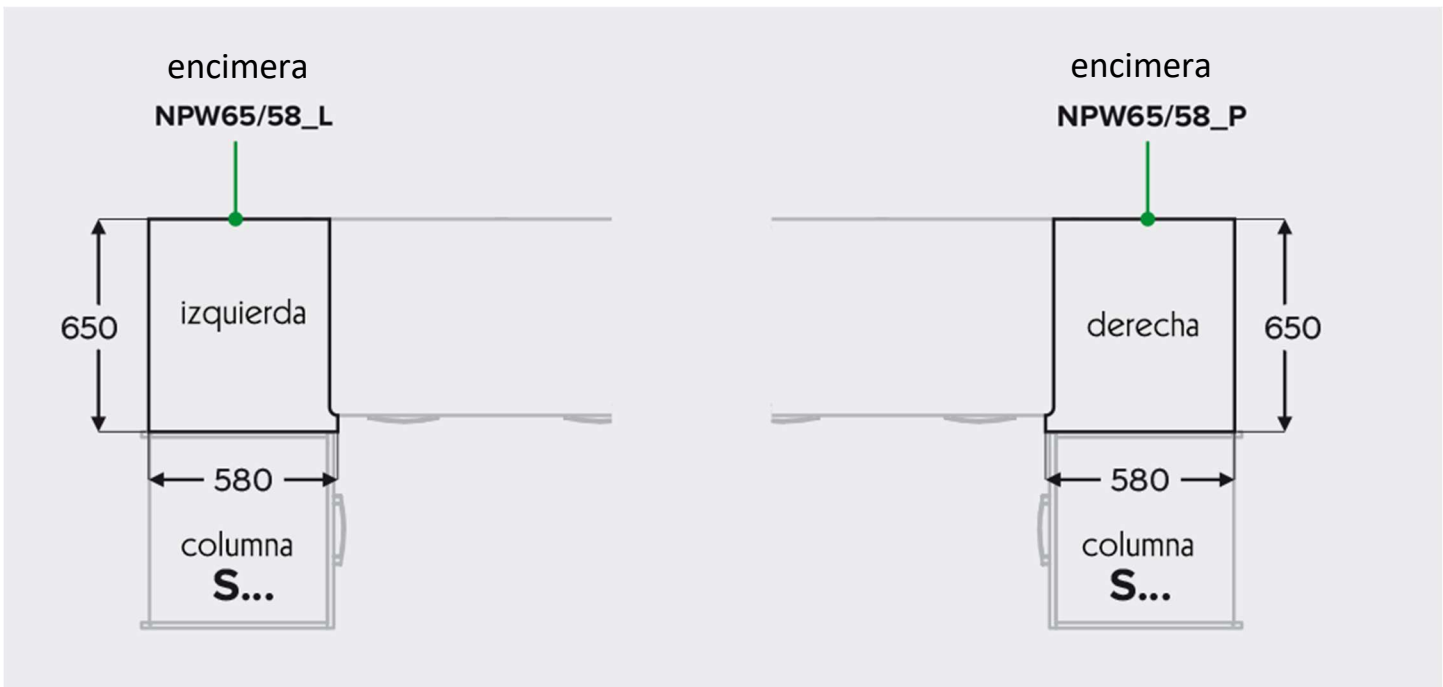
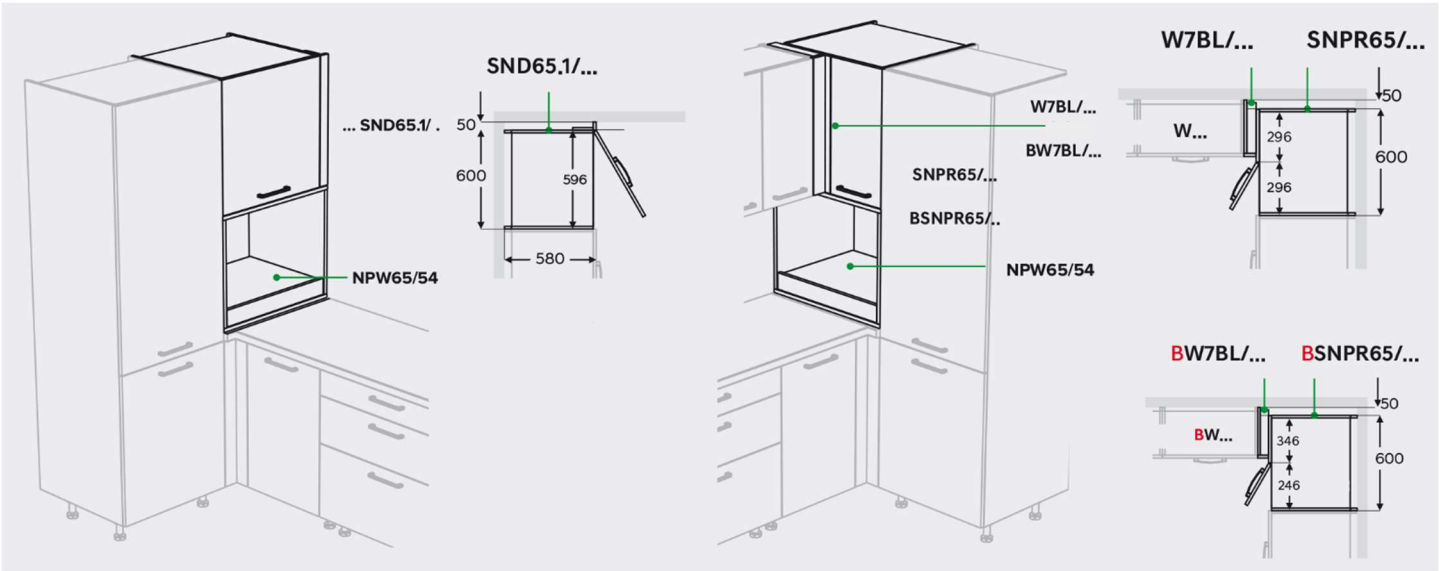

símbolo	ancho cm	descripción
NPW65/54	65	Armario con estante extraíble para electrodomésticos independientes, (tipo Thermomix o cafetera) hecho con tablero frontal P2



FALDÓN PARA ARMARIOS ESQUINEROS



símbolo	ancho cm	descripción
W7BL/29	7	altura: 29 cm fondo: 32 cm
BW7BL/29	7	altura: 29 cm fondo: 36 cm



símbolo	ancho cm	descripción
W7BL/71	7	altura: 71 cm fondo: 32 cm
BW7BL/71	7	altura: 71 cm fondo: 36 cm

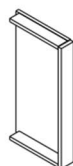

símbolo	ancho cm	descripción
W7BL/35	7	altura: 35 cm fondo: 32 cm
BW7BL/35	7	altura: 35 cm fondo: 36 cm

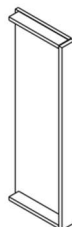

símbolo	ancho cm	descripción
W7BL/90	7	altura: 90 cm fondo: 32 cm
BW7BL/90	7	altura: 90 cm fondo: 36 cm

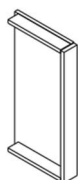

símbolo	ancho cm	descripción
W7BL/61	7	altura: 61 cm fondo: 32 cm
BW7BL/61	7	altura: 61 cm fondo: 36 cm

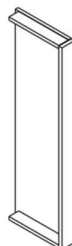

símbolo	ancho cm	descripción
W7BL/100	7	altura: 100 cm fondo: 32 cm
BW7BL/100	7	altura: 100 cm fondo: 36 cm

ARMARIOS COMPLEMENTARIOS

... / 61

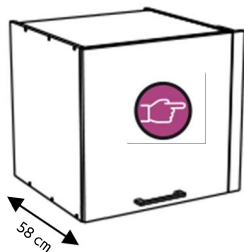

símbolo	ancho cm	descripción
SND65 .1/61	65	para completar la instalación de armarios esquineros derecha/izquierda

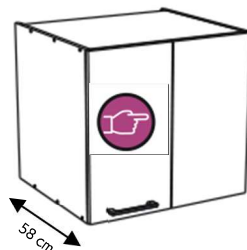

símbolo	ancho cm	descripción
SNPR65 /61	65	para completar la instalación de armarios esquineros derecha/izquierda
BSNPR65/61	65	



... / 71

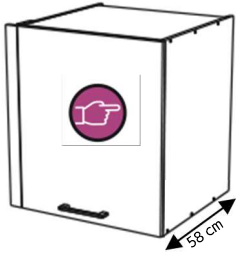

símbolo	ancho cm	descripción
SND65.1/71	65	para completar la instalación de armarios esquineros derecha/izquierda

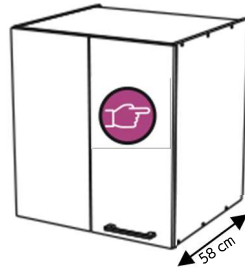

símbolo	ancho cm	descripción
SNPR65 /71	65	para completar la instalación de armarios esquineros derecha/izquierda
BSNPR65/71	65	

... / 90

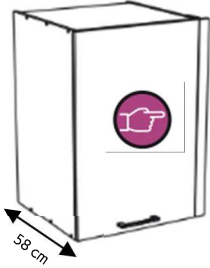

símbolo	ancho cm	descripción
SND65.1/90	65	para completar la instalación de armarios esquineros derecha/izquierda

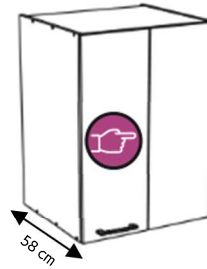

símbolo	ancho cm	descripción
SNPR65 /90	65	para completar la instalación de armarios esquineros derecha/izquierda
BSNPR65/90	65	

... / 100

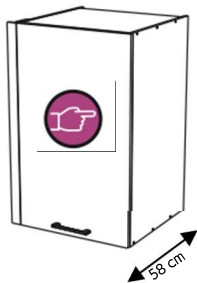

símbolo	ancho cm	descripción
SND65.1/100	65	para completar la instalación de armarios esquineros derecha/izquierda

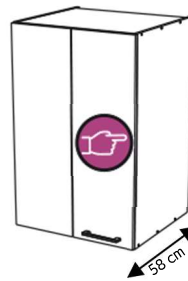

símbolo	ancho cm	descripción
SNPR65 /100	65	para completar la instalación de armarios esquineros derecha/izquierda
BSNPR65/100	65	



ARMARIOS SUPERIORES



push-to-open: abre con un ligero empujón en el panel frontal. Opción disponible para armarios sobre electrodomésticos con frontales: P2, P4, M4 y F



apertura con hueco para los dedos



cornisa con iluminación y apertura con hueco para los dedos

opciones para abrir sin tiradores

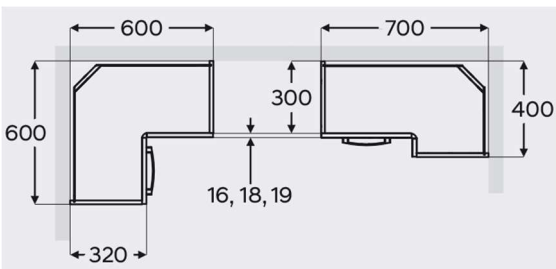

ALTO: 61 CM
FONDO: W ... - 32 CM
BW ... - 36 CM

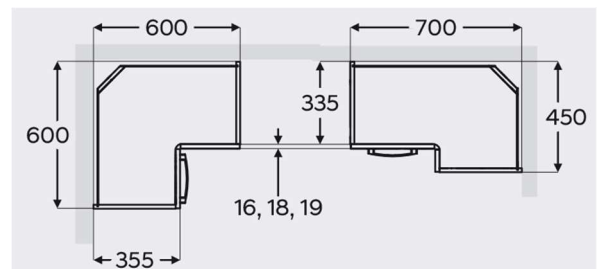



.../61



símbolo	ancho cm	descripción
W... /61	15*/20*/30/35 40/45/50/55/60	armario superior con baldas, fondo de 32 cm / 36 cm *armario sin tirador
BW... /61	15*/20*/30/35 40/45/50/55/60	

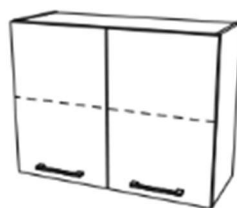

símbolo	ancho cm	descripción
W.../61	60/70/80	armario superior con dos puertas, baldas y fondo de 32 cm / 36 cm
BW.../61	60/70/80	



símbolo	ancho cm	descripción
WS60.1 /61	60	armario superior con escurreplatos de dos niveles, fondo de 32 cm / 36 cm
BWS60.1 /61	60	



símbolo	ancho cm	descripción
WS ... /61	60/80	armario superior de dos puertas, con escurreplatos de dos niveles, fondo de 32 cm / 36 cm
BWS ... /61	60/80	



símbolo	ancho cm	descripción
WRP70x40 /61	60	armario superior esquinero sin cierre suave
BWRP70x45 /61	60	

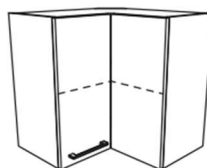

símbolo	ancho cm	descripción
WRP60x60 /61	60x60	armario superior esquinero sin cierre suave
BWRP65x65 /61	65x65	

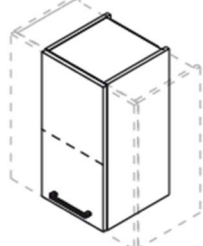

símbolo	ancho cm	descripción
W1/61_SPEC	20 < ... > 59	armario especial, ancho cada 1 cm con una puerta
BW1/61_SPEC	20 < ... > 59	

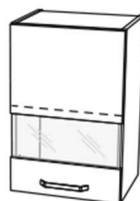

símbolo	ancho cm	descripción
WW1/61	40/45/ 50/60	armario con el cristal blanco mate (frentes P2, K2, P4, M4)
BWW1/61	40/45/ 50/60	



ARTE COCINA DESIGN

www.artecocinadesign.com

tel.: (0034) 611 580 888



símbolo	ancho cm	descripción
WW ... /61	40/45/ 50/60	armario con el cristal blanco mate o transparente (frentes F4, F7, F8)
BWW ... /61	40/45/ 50/60	

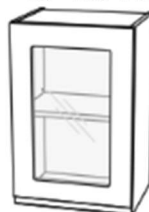

símbolo	ancho cm	descripción
WW ... /61	40/45/ 50/60	armario con el cristal blanco mate o transparente (frentes F6, F11, L4*)
BWW ... /61	40/45/ 50/60	

*no hay opción de elegir el modo de apertura



símbolo	ancho cm	descripción
WW80 /61	80	armario superior con dos puertas, con el cristal blanco mate (frentes P2, K2, P4, M4)
BWW80 /61	80	



símbolo	ancho cm	descripción
WW80 /61	80	armario superior con dos puertas, con el cristal blanco mate o transparente (frentes F4, F7, F8)
BWW80 /61	80	

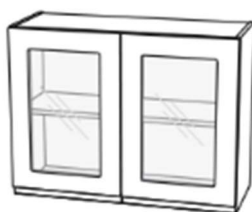

símbolo	ancho cm	descripción
WW80 /61	80	armario superior con dos puertas, con el cristal blanco mate o transparente (frentes F6, F11, L4*)
BWW80 /61	80	

*no hay opción de elegir el modo de apertura

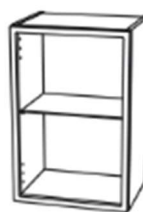

símbolo	ancho cm	descripción
WWAR ... /61	40/60	armario de 1 puerta con el marco de aluminio (negro o dorado), cristal transparente o antisol (grafito oscuro), estanterías de vidrio, cornisa superior con iluminación
BWWAR ... /61	40/60	

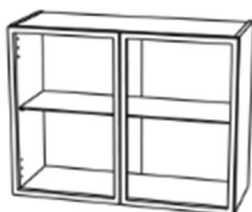

símbolo	ancho cm	descripción
WWAR80 /61	40/60	armario de 2 puertas con marcos de aluminio (negro o dorado), cristal transparente o antisol (grafito oscuro), estanterías de vidrio, cornisa superior con iluminación
BWWAR80 /61	40/60	



.../71

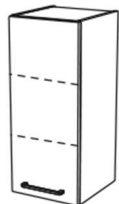

símbolo	ancho cm	descripción
W... .1/71	15*/20*/30/35 40/45/50/55/60	armario superior con baldas, fondo de 32 cm /36 cm *armario sin tirador
BW... .1/71	15*/20*/30/35 40/45/50/55/60	

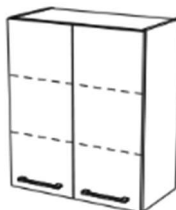

símbolo	ancho cm	descripción
W.../71	60/70/80	armario superior con dos puertas, baldas y fondo de 32 cm / 36 cm
BW.../71	60/70/80	



símbolo	ancho cm	descripción
WS60.1 /71	60	armario superior con escurreplatos de dos niveles, fondo de 32 cm / 36 cm
BWS60.1 /71	60	



símbolo	ancho cm	descripción
WS ... /71	60/80	armario superior de dos puertas, con escurreplatos de dos niveles, fondo de 32 cm / 36 cm
BWS ... /71	60/80	



símbolo	ancho cm	descripción
WRP70x40 /71	60	armario superior esquinero sin cierre suave
BWRP70x45 /71	60	

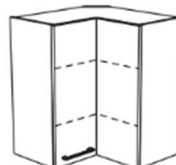

símbolo	ancho cm	descripción
WRP60x60 /71	60x60	armario superior esquinero sin cierre suave
BWRP65x65 /71	65x65	

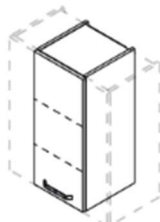

símbolo	ancho cm	descripción
W1/71_SPEC	20 < ... > 59	armario especial, ancho cada 1 cm con una puerta
BW1/71_SPEC	20 < ... > 59	

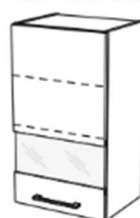

símbolo	ancho cm	descripción
WW1/71	40/45/ 50/60	armario con el cristal blanco mate (frentes P2, K2, P4, M4)
BWW1/71	40/45/ 50/60	

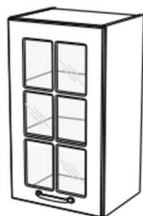

símbolo	ancho cm	descripción
WW1/71	40/45/ 50/60	armario con el cristal blanco mate o transparente (frentes F4, F7, F8)
BWW1/71	40/45/ 50/60	

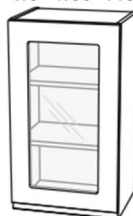

símbolo	ancho cm	descripción
WW1/71	40/45/ 50/60	armario con el cristal blanco mate o transparente (frentes F6, F11, L4*)
BWW1/71	40/45/ 50/60	

*no hay opción de elegir el modo de apertura

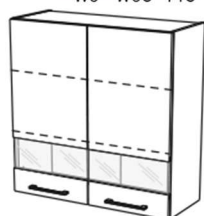

símbolo	ancho cm	descripción
WW80 /71	80	armario superior con dos puertas, con el cristal blanco mate (frentes P2, K2, P4, M4)
BWW80 /71	80	



símbolo	ancho cm	descripción
WW80 /71	80	armario superior con dos puertas, con el cristal blanco mate o transparente (frentes F4, F7, F8)
BWW80 /71	80	



símbolo	ancho cm	descripción
WW80 /71	80	armario superior con dos puertas, con el cristal blanco mate o transparente (frentes F6, F11, L4*)
BWW80 /71	80	

*no hay opción de elegir el modo de apertura



símbolo	ancho cm	descripción
WWAR1/71	40/60	armario de 1 puerta con el marco de aluminio (negro o dorado), cristal transparente o antisol (grafito oscuro), estanterías de vidrio, cornisa superior con iluminación
BWWAR1/71	40/60	



símbolo	ancho cm	descripción
WWAR80 /71	40/60	armario de 2 puertas con marcos de aluminio (negro o dorado), cristal transparente o antisol (grafito oscuro), estanterías de vidrio, cornisa superior con iluminación
BWWAR80 /71	40/60	



... / 90

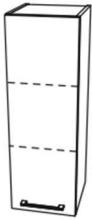

símbolo	ancho cm	descripción
W... .1/90	15*/20*/30/35 40/45/50/55/60	armario superior con baldas, fondo de 32 cm / 36 cm *armario sin tirador
BW... .1/90	15*/20*/30/35 40/45/50/55/60	

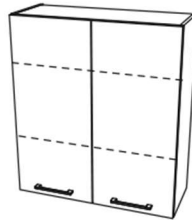

símbolo	ancho cm	descripción
W... /90	60/70/80	armario superior con dos puertas, baldas y fondo de 32 cm / 36 cm
BW... /90	60/70/80	

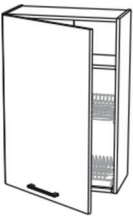

símbolo	ancho cm	descripción
WS60.1 /90	60	armario superior con escurreplatos de dos niveles, fondo de 32 cm / 36 cm
BWS60.1 /90	60	



símbolo	ancho cm	descripción
WS ... /90	60/80	armario superior de dos puertas, con escurreplatos de dos niveles, fondo de 32 cm / 36 cm
BWS ... /90	60/80	

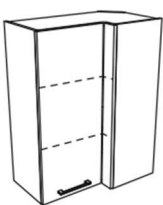

símbolo	ancho cm	descripción
WRP70x40 /90	60	armario superior esquinero sin cierre suave
BWRP70x45 /90	60	

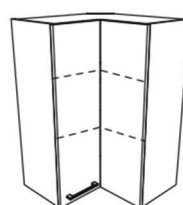

símbolo	ancho cm	descripción
WRP60x60 /90	60x60	armario superior esquinero sin cierre suave
BWRP65x65 /90	65x65	

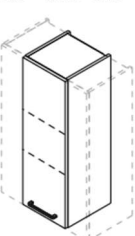

símbolo	ancho cm	descripción
W1/90_SPEC	20 < ... > 59	armario especial, ancho cada 1 cm con una puerta
BW1/90_SPEC	20 < ... > 59	

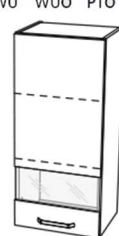

símbolo	ancho cm	descripción
WW1/90	40/45/ 50/60	armario con el cristal blanco mate (frentes P2, K2, P4, M4)
BWW1/90	40/45/ 50/60	

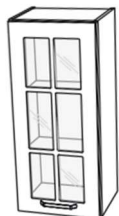

símbolo	ancho cm	descripción
WW1/90	40/45/ 50/60	armario con el cristal blanco mate o transparente (frentes F4, F7, F8)
BWW1/90	40/45/ 50/60	

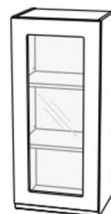

símbolo	ancho cm	descripción
WW1/90	40/45/ 50/60	armario con el cristal blanco mate o transparente (frentes F6, F11, L4*)
BWW1/90	40/45/ 50/60	

*no hay opción de elegir el modo de apertura

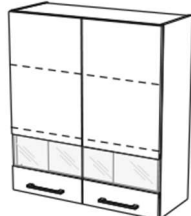

símbolo	ancho cm	descripción
WW80 /90	80	armario superior con dos puertas, con el cristal blanco mate (frentes P2, K2, P4, M4)
BWW80 /90	80	



símbolo	ancho cm	descripción
WW80 /90	80	armario superior con dos puertas, con el cristal blanco mate o transparente (frentes F4, F7, F8)
BWW80 /90	80	

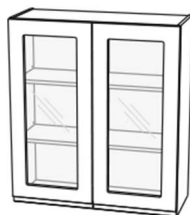

símbolo	ancho cm	descripción
WW80 /90	80	armario superior con dos puertas, con el cristal blanco mate o transparente (frentes F6, F11, L4*)
BWW80 /90	80	

*no hay opción de elegir el modo de apertura

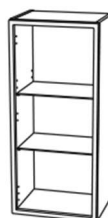

símbolo	ancho cm	descripción
WWAR1/90	40/60	armario de 1 puerta con el marco de aluminio (negro o dorado), cristal transparente o antisol (grafito oscuro), estanterías de vidrio, cornisa superior con iluminación
BWWAR1/90	40/60	

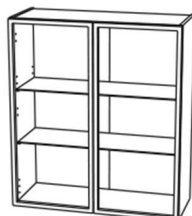

símbolo	ancho cm	descripción
WWAR80 /90	40/60	armario de 2 puertas con marcos de aluminio (negro o dorado), cristal transparente o antisol (grafito oscuro), estanterías de vidrio, cornisa superior con iluminación
BWWAR80 /90	40/60	



... / 100

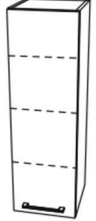

símbolo	ancho cm	descripción
W... .1/100	15*/20*/30/35 40/45/50/55/60	armario superior con baldas, fondo de 32 cm / 36 cm *armario sin tirador
BW... .1/100	15*/20*/30/35 40/45/50/55/60	

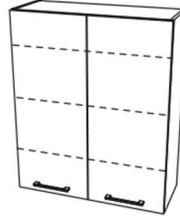

símbolo	ancho cm	descripción
W... /100	60/70/80	armario superior con dos puertas, baldas y fondo de 32 cm / 36 cm
BW... /100	60/70/80	

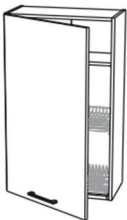

símbolo	ancho cm	descripción
WS60.1 /100	60	armario superior con escurreplatos de dos niveles, fondo de 32 cm / 36 cm
BWS60.1 /100	60	



símbolo	ancho cm	descripción
WS ... /100	60/80	armario superior de dos puertas, con escurreplatos de dos niveles, fondo de 32 cm / 36 cm
BWS ... /100	60/80	

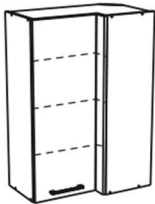

símbolo	ancho cm	descripción
WRP70x40 /100	60	armario superior esquinero sin cierre suave
BWRP70x45 /100	60	

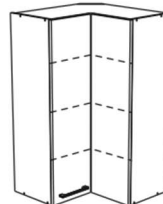

símbolo	ancho cm	descripción
WRP60x60 /100	60x60	armario superior esquinero sin cierre suave
BWRP65x65 /100	65x65	

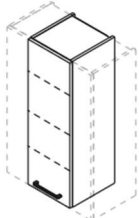

símbolo	ancho cm	descripción
W1/100_SPEC	20 < ... > 59	armario especial, ancho cada 1 cm con una puerta
BW1/100_SPEC	20 < ... > 59	

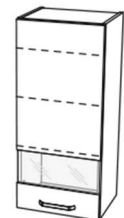

símbolo	ancho cm	descripción
WW1/100	40/45/ 50/60	armario con el cristal blanco mate (frentes P2, K2, P4, M4)
BWW1/100	40/45/ 50/60	

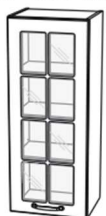

símbolo	ancho cm	descripción
WW1/100	40/45/ 50/60	armario con el cristal blanco mate o transparente (frentes F4, F7, F8)
BWW1/100	40/45/ 50/60	

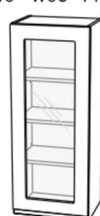

símbolo	ancho cm	descripción
WW1/100	40/45/ 50/60	armario con el cristal blanco mate o transparente (frentes F6, F11, L4*)
BWW1/100	40/45/ 50/60	

*no hay opción de elegir el modo de apertura

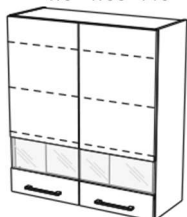

símbolo	ancho cm	descripción
WW80 /100	80	armario superior con dos puertas, con el cristal blanco mate (frentes P2, K2, P4, M4)
BWW80 /100	80	

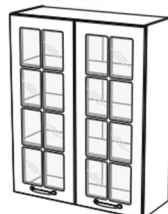

símbolo	ancho cm	descripción
WW80 /100	80	armario superior con dos puertas, con el cristal blanco mate o transparente (frentes F4, F7, F8)
BWW80 /100	80	



símbolo	ancho cm	descripción
WW80 /100	80	armario superior con dos puertas, con el cristal blanco mate o transparente (frentes F6, F11, L4*)
BWW80 /100	80	

*no hay opción de elegir el modo de apertura

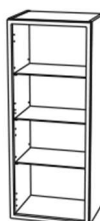

símbolo	ancho cm	descripción
WWAR1/100	40/60	armario de 1 puerta con el marco de aluminio (negro o dorado), cristal transparente o antisol (grafito oscuro), estanterías de vidrio, cornisa superior con iluminación
BWWAR1/100	40/60	



símbolo	ancho cm	descripción
WWAR80 /100	40/60	armario de 2 puertas con marcos de aluminio (negro o dorado), cristal transparente o antisol (grafito oscuro), estanterías de vidrio, cornisa superior con iluminación
BWWAR80 /100	40/60	



W ... / 29

ALTO: 29 CM
FONDO: W ... - 32 CM
BW ... - 36 CM

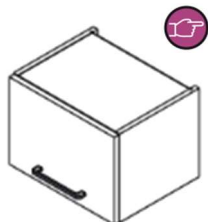

símbolo	ancho cm	descripción
WO.../29	40/45/	armario con el pistón automático
BWO.../29	50/60/ 70/80/ 90/95	

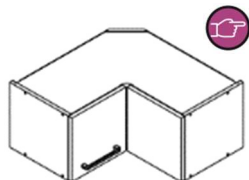

símbolo	ancho cm	descripción
WRP.../29	60/65	armario con una puerta
BWRP.../29		

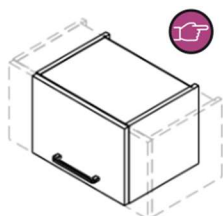

símbolo	ancho cm	descripción
WO.../29_SPEC	41 < ...	armario especial, ancho cada 1 cm con el pistón automático
BWO.../29_SPEC	> 65	

W ... / 29N

ALTO: 29 CM
FONDO: 58 CM

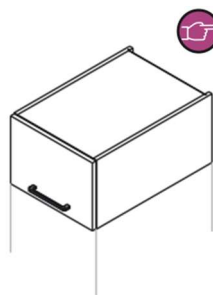

símbolo	ancho cm	descripción
WO.../29N	30/40/4	armario montado encima de las columnas con el pistón automático
BWO.../29N	5/50/60/ 70/75/8 0/85/90/ 95/100	



símbolo	ancho cm	descripción
SNO.../29N	60/75/ 90/95/ 100	armario montado encima de los electrodomésticos, con más espacio para ventilación, con el pistón automático

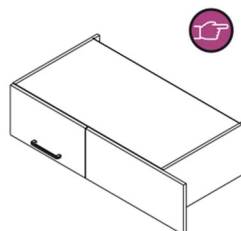

símbolo	ancho cm	descripción
SNOPR115/29N	115	armario montado encima de la despensa, opción izquierda y derecha, pistón automático

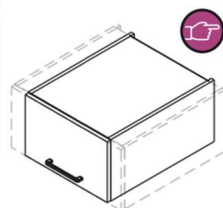

símbolo	ancho cm	descripción
WO.../29N_SPEC	41 < ... > 65	armario montado encima de la columna, ancho cada 1 cm con el pistón automático



W ... / 35

ALTO: 35 CM
FONDO: W ... - 32 CM
BW ... - 36 CM

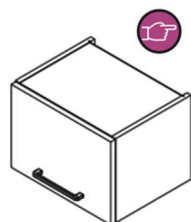

símbolo	ancho cm	descripción
WO.../35 BWO.../35	40/45/ 50/60/ 70/80/ 90/95	armario con el pistón automático



símbolo	ancho cm	descripción
WRP.../35 BWRP.../35	60/65	armario con una puerta

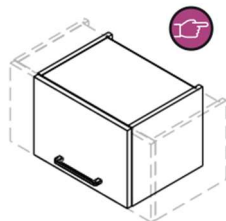

símbolo	ancho cm	descripción
WO.../35_SPEC BWO.../35_SPEC	41 < ... > 65	armario especial, ancho cada 1 cm con el pistón automático

W ... / 35N

ALTO: 35 CM
FONDO: 58 CM



símbolo	ancho cm	descripción
WO.../35N	30/40/45/ 50/60/70/ 75/80/85/ 90/95/100	armario sobre columnas con el pistón automático



símbolo	ancho cm	descripción
WO.../35N	30/40/45/ 50/60/70/ 75/80/85/ 90/95/ 100	montaje encima de las columnas con electrodomésticos, con el espacio de ventilación aumentado, sin soportes a la pared

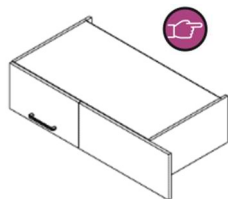

símbolo	ancho cm	descripción
SNOPR 115/35N	115	montaje sobre la despensa esquinera con el pistón automático

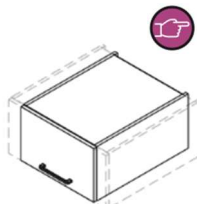

símbolo	ancho cm	descripción
WO.../35N_SPEC	41 < ... > 65	armario especial sobre columnas, ancho cada 1 cm con el pistón automático



ARMARIOS PARA MICROONDAS

ALTO: 71 CM
FONDO: W ... - 32 CM
BW ... - 36 CM



símbolo	ancho cm	descripción
WOM1Z60/71	60	armario para microondas integrado (595mm x 383mm) con el pistón automático
BWOM1Z60/71		

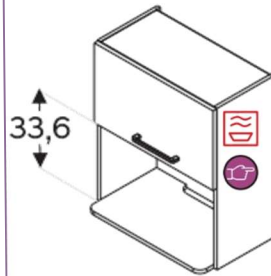

símbolo	ancho cm	descripción
WOM60/71	60	armario para microondas independiente con el pistón automático
BWOM60/71		

ALTO: 90 CM
FONDO: W ... - 32 CM
BW ... - 36 CM



símbolo	ancho cm	descripción
WOM1Z60/90	60	armario para microondas integrado (595mm x 383mm) con el pistón automático
BWOM1Z60/90		

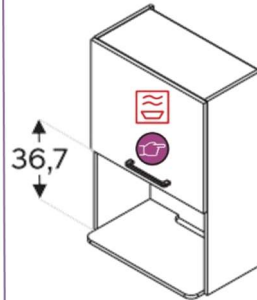

símbolo	ancho cm	descripción
WOM60/90	60	armario para microondas independiente con el pistón automático
BWOM60/90		

ALTO: 100 CM
FONDO: W ... - 32 CM
BW ... - 36 CM

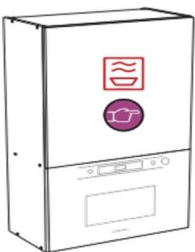

símbolo	ancho cm	descripción
WOM1Z60/100	60	armario para microondas integrado (595mm x 383mm) con el pistón automático
BWOM1Z60/100		

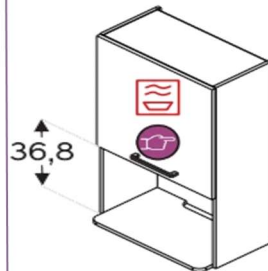

símbolo	ancho cm	descripción
WOM60/100	60	armario para microondas independiente con el pistón automático
BWOM60/100		



ARMARIOS PARA CAMPANAS EXTRACTORAS SOBRE LA PLACA DE GAS

OAKAP P1



OKAP P1B



OKAP P1C



FONDO: W ... - 32 CM
BW ... - 36 CM

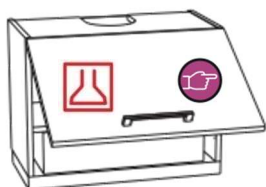

símbolo	ancho cm	descripción
WO60/42P1 WO60/42P1B WO60/42P1C	60	armario para campanas extractoras con el pistón automático, 42cm de alto, para armarios de 61cm de altura
BWO60/42P1 BWO60/42P1B BWO60/42P1C		

· La altura mínima de instalación sobre la placa de gas es de 65 cm.

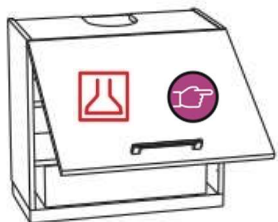

símbolo	ancho cm	descripción
WO60/51P1 WO60/51P1B WO60/51P1C	60	armario para campanas extractoras con el pistón automático, 51cm de alto, para armarios de 71cm de altura
BWO60/51P1 BWO60/51P1B BWO60/51P1C		

· La altura mínima de instalación sobre la placa de gas es de 65 cm.

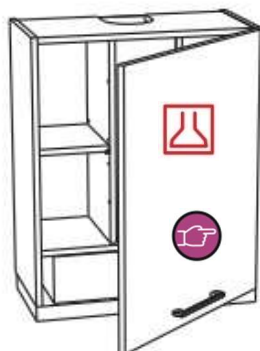

símbolo	ancho cm	descripción
WO60.1/P1 WO60.1/P1B WO60.1/P1C	60	armario para campanas extractoras apertura izq./dcha., 71cm de alto, para armarios de 90cm de altura
BWO60.1/P1 BWO60.1/P1B BWO60.1/P1C		

· La altura mínima de instalación sobre la placa de gas es de 65 cm.



ARMARIOS PARA CAMPANAS EXTRACTORAS SOBRE LA PLACA DE INDUCCIÓN

OKAP P3B



OKAP P3C



FONDO: W ... - 32 CM
BW ... - 36 CM

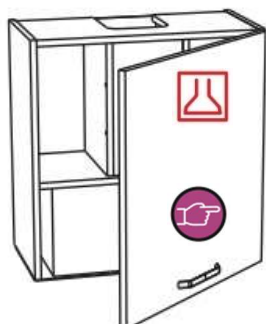

símbolo	ancho cm	descripción
WP3B60.1/61 WP3C60.1/61	60	armario para campanas extractoras apertura izq./dcha., para armarios de 61cm de altura
BWP3B60.1/61 BWP3C60.1/61		

· La altura mínima de instalación sobre la placa de inducción es de 50 cm.

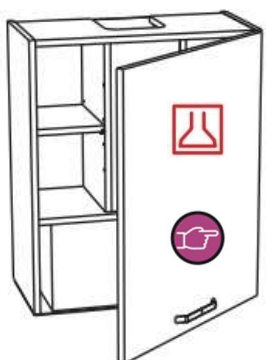

símbolo	ancho cm	descripción
WP3B60.1/71 WP3C60.1/71	60	armario para campanas extractoras apertura izq./dcha., para armarios de 71cm de altura
BWP3B60.1/71 BWP3C60.1/71		

· La altura mínima de instalación sobre la placa de inducción es de 50 cm.

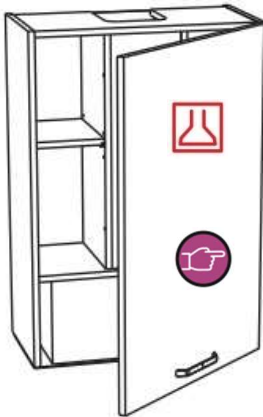

símbolo	ancho cm	descripción
WP3B60.1/90 WP3C60.1/90	60	armario para campanas extractoras apertura izq./dcha., para armarios de 90cm de altura
BWP3B60.1/90 BWP3C60.1/90		

· La altura mínima de instalación sobre la placa de inducción es de 50 cm.

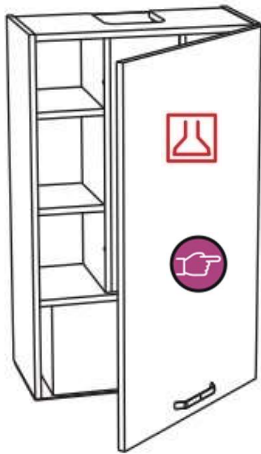

símbolo	ancho cm	descripción
WP3B60.1/100 WP3C60.1/100	60	armario para campanas extractoras apertura izq./dcha., para armarios de 100cm de altura
BWP3B60.1/100 BWP3C60.1/100		

· La altura mínima de instalación sobre la placa de inducción es de 50 cm.

OKAP P4C



FONDO: W ... - 32 CM
BW ... - 36 CM

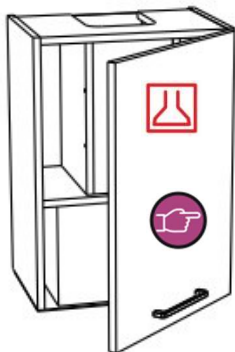

símbolo	ancho cm	descripción
WP4C45.1/61 BWP4C45.1/61	45	armario para campanas extractoras apertura izq./dcha., para armarios de 61cm de altura

· La altura mínima de instalación sobre la placa de inducción es de 50 cm.

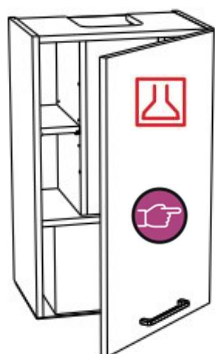

símbolo	ancho cm	descripción
WP4C45.1/71	45	armario para campanas extractoras apertura izq./dcha., para armarios de 71cm de altura
BWP4C45.1/71		

· La altura mínima de instalación sobre la placa de inducción es de 50 cm.

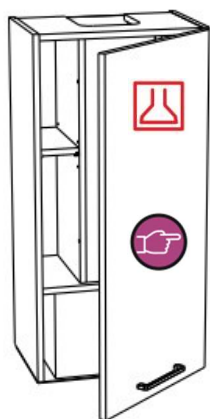

símbolo	ancho cm	descripción
WP4C45.1/90	45	armario para campanas extractoras apertura izq./dcha., para armarios de 90cm de altura
BWP4C45.1/90		

· La altura mínima de instalación sobre la placa de inducción es de 50 cm.

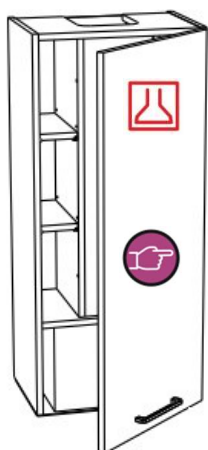

símbolo	ancho cm	descripción
WP4C45.1/100	45	armario para campanas extractoras apertura izq./dcha., para armarios de 100cm de altura
BWP4C45.1/100		

· La altura mínima de instalación sobre la placa de inducción es de 50 cm.



OKAP P8C



FONDO: W ... - 32 CM
BW ... - 36 CM

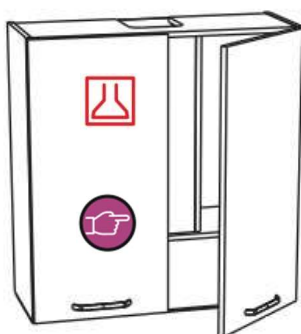

símbolo	ancho cm	descripción
WP8C80/71	80	armario para campanas extractoras apertura izq./dcha., para armarios de 71cm de altura
BWP8C80/71		

· La altura mínima de instalación sobre la placa de inducción es de 50 cm.

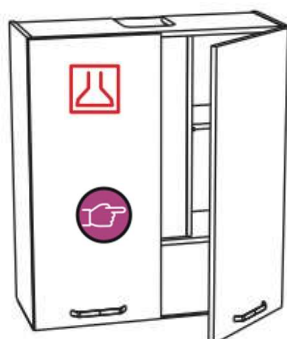

símbolo	ancho cm	descripción
WP8C80/90	80	armario para campanas extractoras apertura izq./dcha., para armarios de 90cm de altura
BWP8C80/90		

· La altura mínima de instalación sobre la placa de inducción es de 50 cm.

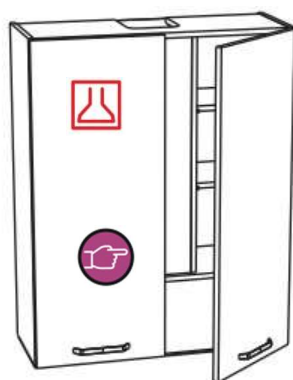

símbolo	ancho cm	descripción
WP8C80/100	80	armario para campanas extractoras apertura izq./dcha., para armarios de 100cm de altura
BWP8C80/100		

· La altura mínima de instalación sobre la placa de inducción es de 50 cm.



ARMARIOS SOBRE LAVAVAJILLAS / LAVADORA

ALTURA: 118,1 CM

1SS/61: cajón de cierre suave (soft close)

1ST/61: cajón de cierre suave (Blum)

.../61

FONDO: 58 CM

.../71

ALTURA: 127,7 CM

1SS/71: cajón de cierre suave (soft close)

1ST/71: cajón de cierre suave (Blum)



símbolo	ancho cm	descripción
NWPD...1SS/61	45/60	armario con cajón sobre lavavajillas/lavadora y espacio para horno, puertas superiores con apertura izq./dcha.
NWPD...1ST/61		

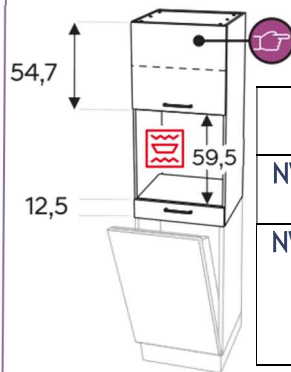

símbolo	ancho cm	descripción
NWPD...1SS/71	45/60	armario con cajón sobre lavavajillas/lavadora y espacio para horno, puertas superiores con apertura izq./dcha.
NWPD...1ST/71		

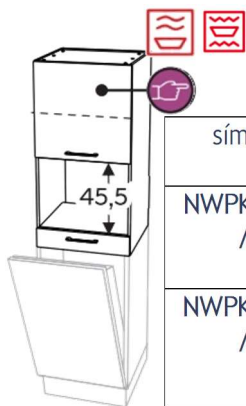

símbolo	ancho cm	descripción
NWPKD...1SS/61	45/60	armario con cajón sobre lavavajillas/lavadora y espacio para horno compacto o microondas, puertas superiores con apertura izq./dcha.
NWPKD...1ST/61		

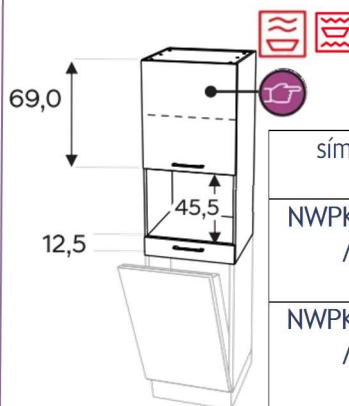

símbolo	ancho cm	descripción
NWPKD...1SS/71	45/60	armario con cajón sobre lavavajillas/lavadora y espacio para horno compacto o microondas, puertas superiores con apertura izq./dcha.
NWPKD...1ST/71		

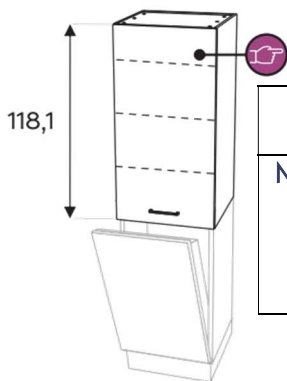

símbolo	ancho cm	descripción
NWD...1/61	45/60	armario sobre lavavajillas/lavadora, puertas superiores con apertura izq./dcha.

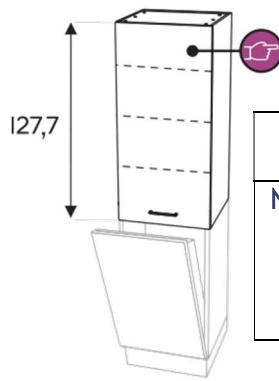

símbolo	ancho cm	descripción
NWD...1/71	45/60	armario sobre lavavajillas/lavadora, puertas superiores con apertura izq./dcha.



ARTE COCINA DESIGN

www.artecocinadesign.com
tel.: (0034) 611 580 888

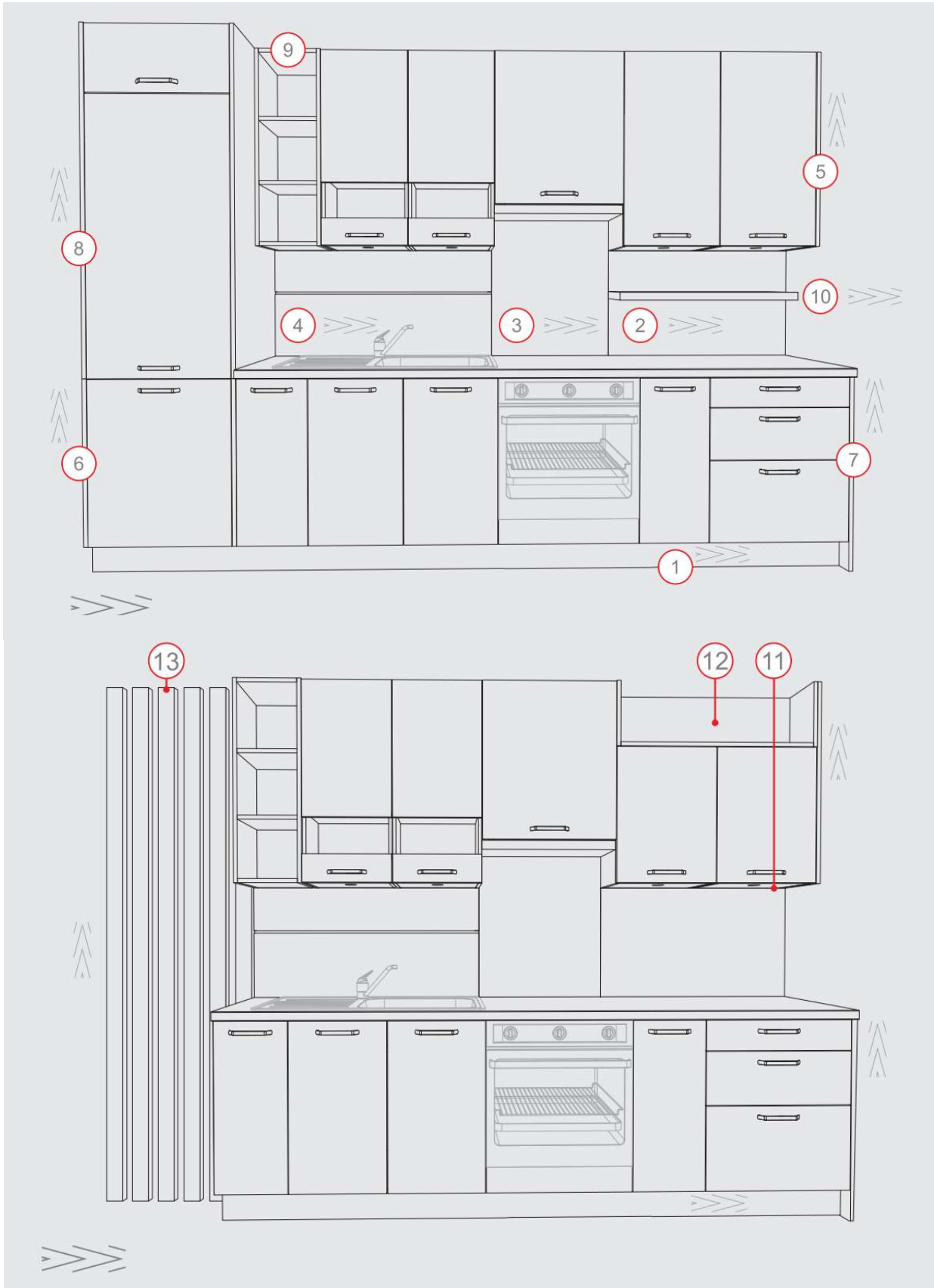



ISLAS DE COCINA

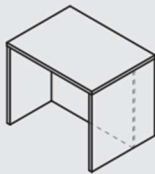
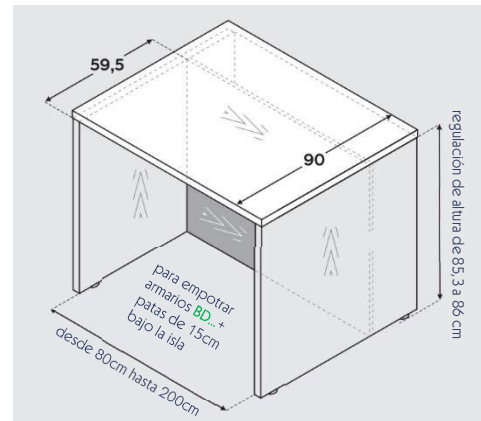
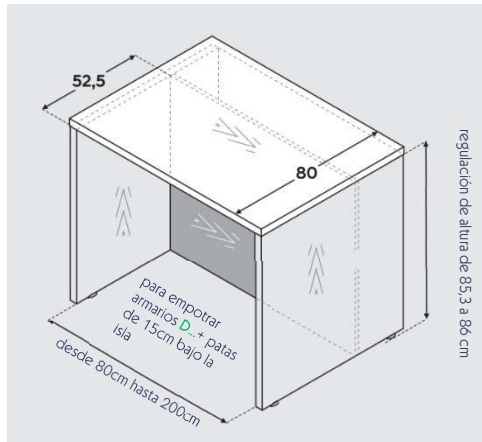

ZW8LPB

- isla con encimera, grosor 3,6cm
- pata izquierda: 80cm
- pata derecha: 80cm
- panel divisor

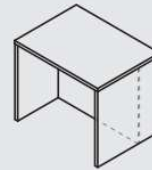

ZW9LPB

- isla con encimera, grosor 3,6cm
- pata izquierda: 90cm
- pata derecha: 90cm
- panel divisor

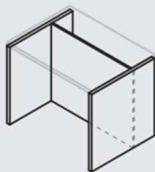

ZW8LP

- isla sin encimera
- pata izquierda: 80cm
- pata derecha: 80cm
- panel divisor

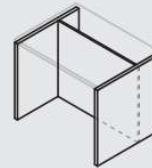

ZW9LP

- isla sin encimera
- pata izquierda: 90cm
- pata derecha: 90cm
- panel divisor

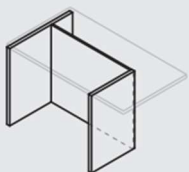

ZW8L6P

- isla sin encimera
- pata izquierda: 80cm
- pata derecha: 55cm
- panel divisor

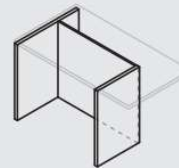

ZW9L7P

- isla sin encimera
- pata izquierda: 90cm
- pata derecha: 62cm
- panel divisor

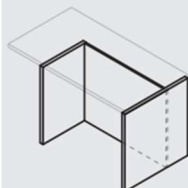

ZW6L8P

- isla sin encimera
- pata izquierda: 55cm
- pata derecha: 80cm
- panel divisor

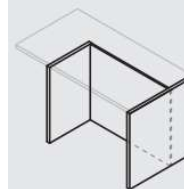

ZW7L9P

- isla sin encimera
- pata izquierda: 62cm
- pata derecha: 90cm
- panel divisor



colores encimera: página 24 del catálogo de inspiración



colores de patas: P2



colores de panel divisor: P2 y P4



MESAS

BANCOS

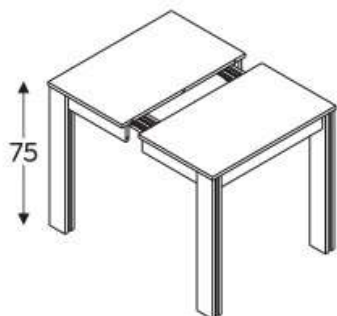

100/150 x 80
90/135/180 x 75
120/161/202 x 88

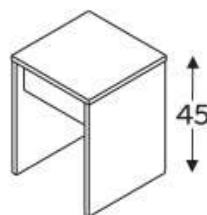

34 x 34

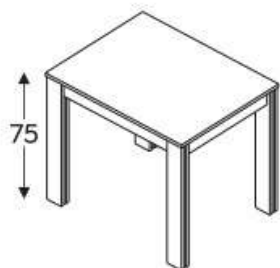

90 x 70
110 x 60
120 x 75
140 x 80

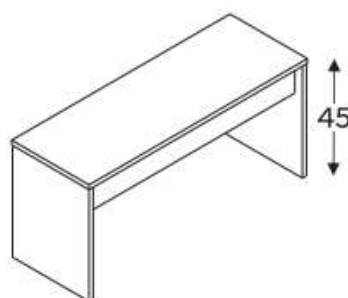

96 x 34



TABURETES

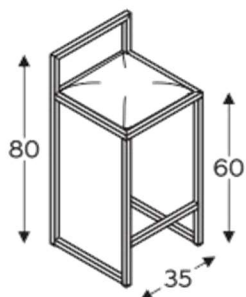

LOFT60R

· perfil metálico dorado o negro con respaldo
· colores de asientos: página 26 del catálogo de inspiración

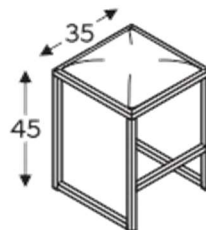

LOFT45

· perfil metálico dorado o negro
· colores de asientos: página 26 del catálogo de inspiración

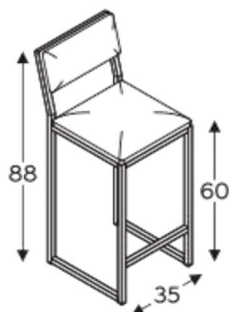

LOFT60BALCK

· perfil metálico negro con respaldo acolchado
· colores de asientos: página 26 del catálogo de inspiración

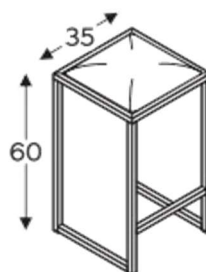

LOFT60

· perfil metálico dorado o negro
· colores de asientos: página 26 del catálogo de inspiración



ARTE COCINA DESIGN

www.artecocinadesign.com

tel.: (0034) 611 580 888



WWW.ARTECOCINADESIGN.COM

En ArteCocinaDesign queremos ayudarte a hacer realidad tus sueños de cocina y diseño de interiores. Si tienes alguna pregunta, comentario o consulta sobre nuestros productos o servicios, no dudes en ponerte en contacto con nuestro equipo dedicado. Estamos aquí para ofrecerte asistencia experta y responder a todas tus inquietudes.

Nos encantaría saber de ti y ayudarte en todo lo que necesites para crear la cocina de tus sueños. ¡Esperamos poder colaborar contigo pronto!



Anita Duraj
+34 611 580 888
info@artecocinadesign.com

¡Gracias por elegir ArteCocinaDesign!

Todos los derechos reservados. Este catálogo y su contenido están protegidos por derechos de autor. Ninguna parte puede ser reproducida o utilizada sin el consentimiento previo por escrito del titular. El uso no autorizado puede acarrear responsabilidades legales.